

**CITY OF LAGRANGE, GEORGIA
WATER SYSTEM SPECIFICATIONS**

Revised: 1/17/20

MATERIALS

The types of materials allowed in the City's water system shall be approved by the City's Water Division Superintendent, but shall typically be of the types discussed in this section. Materials must be manufactured in the United States, unless otherwise approved, satisfy all applicable AWWA Standards, and comply with all Federal, State, and Local regulations. Any variation in the types of materials or manufacturers listed below requires prior written approval from the Water Superintendent in order to be accepted.

DUCTILE IRON PIPE AND FITTINGS

- ◆ 4"-12" DIP shall be in accordance with ANSI/AWWA 150/A21.50 and ANSI/AWWA C151/A21.51 pressure class 350 with cement lining in accordance with ANSI/AWWA C104/A21.4. For specific projects and areas subject to heavy loads, the City may specify thicker special class pipe.
- ◆ 16" and larger DIP shall meet the same specifications as smaller pipe but with a pressure class of 250.
- ◆ In general, pipe shall be equipped with push-on joints equivalent to Tyton, Fastite, or Super Belltite. Pipe for highway crossings, creek crossings, railroad crossings, and other specified locations shall be equipped with mechanical joint ends. Retainer glands shall be used as required.
- ◆ Mechanical joint fittings shall be class 350 ductile iron compact fittings in accordance with ANSI/AWWA C153/A21.53 and ANSI/AWWA C111/A21.11 as applicable.
- ◆ Where specified, flanged pipe shall meet ANSI A21.51 and be used with fittings meeting ANSI A21.10.
- ◆ All pipe and fittings shall be asphalt outside, cement-lined inside.
- ◆ Retainer glands are required at each valve or fitting associated with a pipe size reduction, direction change, future stub out, or other area as required.
- ◆ Acceptable ductile iron pipe manufacturers are American Cast Iron Pipe Company and U.S. Pipe and Foundry Company.

TAPPING SLEEVE AND VALVE

- ◆ Tapping sleeves and valves shall be Mueller, mechanical joint, 200 psi or equal.
- ◆ Tapping Sleeves shall have 24"x24"x8" concrete pad in undisturbed soil with solid blocking to support tapping valves.

PVC PIPE AND FITTINGS

- ◆ **In general, PVC pipe is not allowed within the City's public distribution system.**
- ◆ PVC pipe shall meet ASTM D-2241, Class 200 and shall have iron pipe size outside dimensions. PVC compounds used in the manufacturing process shall meet the requirements of ASTM D-1784.
- ◆ The pipe shall have integral bell ends and joints shall be HEP "Bell-Tite" or equivalent. Joints shall comply with ASTM D-3139.
- ◆ Double bell fittings, where allowed, shall have positive pipe stops within the couplings to allow for thermal contraction and expansion.
- ◆ Fittings for existing 6" PVC pipe shall be ductile iron, mechanical joint as described in the section above.
- ◆ PVC pipe shall be stored in accordance with manufacturer recommendations and shall be protected from heat and direct sunlight.
- ◆ Acceptable manufacturers of pipe and fittings are Robintech, Certainteed, Capco, or Vulcan.
- ◆ All plastic water pipes and service lines must bear the National Sanitation Foundation (NSF) seal of approval for potable water use.

COPPER PIPE

- ◆ Pipe sizes from 3/4" to 1" shall be seamless copper water tube meeting ASTM B-88-62, Type K, hard drawn.
- ◆ Fittings shall meet AWWA C800-6 and 66. Corp stops shall be 3/4" Ford F-1000 CC x COMP or equal, curb stops shall be 3/4" Ford B-41-233W COMP x FIP or equal, and service saddles shall be dresser style 194 or equal.
- ◆ All pipe, solder, or flux used in water line repair or installation must be lead-free. Pipes and fittings must not contain more than 8% lead, and solders and flux must not contain more than 0.2% lead.

CASING PIPE

- ◆ Casing pipe, where required under streets and driveways, shall be steel pipe conforming to ASTM A-139, Grade B; electric fusion welded steel pipe. The pipe shall have a minimum tensile strength of 35,000 psi.
- ◆ Spacers shall be stainless steel.

VALVES

- ◆ Note that valves within the City of LaGrange distribution system "**open right.**"

- ◆ Unless otherwise specified, all gate valves up to 12" shall be resilient seat, and all gate valves larger than 12" shall be butterfly type. All valves larger than 12" shall receive approval from the City before installation.
- ◆ Resilient-seat gate valves shall meet AWWA C509 and C550, open right, and use a 2" square wrench nut. Stems shall be non-rising, bronze, and be provided with at least one o-ring above and one o-ring below the integral stem collar. The area between the o-rings shall be filled with lubricant. Anti-friction washers shall be located above and below the thrust collar. The sealing gate shall be cast iron and the rubber compression seat shall seal properly even under unbalanced pressures on either side of the gate.
- ◆ Double-disc valves shall meet AWWA C509 and C550, open right, and use a 2" square wrench nut. Stems shall be non-rising, bronze, and use high-grade packing for geared valves and double o-ring for non-geared valves. Double-disc, parallel set discs, and upper wedges shall be bronze mounted cast iron.
- ◆ Acceptable manufacturers of gate valves are American-Darling and Dresser M&H.

AIR/VACUUM VALVES

- ◆ Air relief valves shall be used in accordance with recommended engineering practices for water pipelines. Valves shall meet AWWA C512-92 and be installed according to manufacturer recommendations.
- ◆ Valves shall contain orifices housed in a single cast iron body and use a stainless steel linkage and spherical float with replaceable Buna-N seat. No plastic linkages shall be allowed. Orifice shall be able to exhaust air up to sonic velocity without blowing shut.
- ◆ Valves 2-inch and smaller shall be Ford B11 style with screwed inlets and a minimum design pressure of 300 psi. Valves 3-inch and larger shall have flanged inlets and be class 250. Outlet cowl assemblies shall be provided for each valve.
- ◆ Acceptable manufacturers are GA Industries.

VALVE ACCESSORIES

- ◆ All buried valves shall be furnished with cast iron, screw type; extendable valve boxes marked "WATER". Acceptable manufacturers are Mueller, M&H Valve, or equal.
- ◆ Valve boxes shall be mounted plumb in an 18" round concrete valve pad and centered over the operating nut.
- ◆ One concrete valve marker shall be furnished and set at each line valve. The marker shall be made of 3,000 psi concrete with four #4 reinforcing bars. The size shall be four feet long by 4" on each side.

HYDRANTS

- ◆ Note that hydrants within the City of LaGrange distribution system “open right.”
- ◆ Fire hydrants shall meet AWWA C-502-80 as well as the following:
 1. Open right with arrow indicator
 2. Three-way, one 4.5” pumper nozzle, two 2.5” hose nozzles, NST threads
 3. Nozzle caps and chains
 4. Maximum pressure drop of 2.55 psi at 1000 gpm at 4.5” pumper nozzle.
 5. Compression type (open against pressure, close with pressure)
 6. Traffic model with upper and lower barrels joined at ground line by separate, breakable, swivel flanges allowing for 360 degree rotation for proper nozzle facing. Bottom barrel shall have a permanent ground line marking providing at least 18” centerline clearance to lowest nozzle.
 7. The lower barrel shall be a single cast unit with a clearly marked bury depth of 4’
 8. 250 psig working pressure
 9. A 5 1/4” main valve opening with inside barrel diameter of 7” for maximum flow. The valve shall be molded rubber and reversible in design to provide a spare in place (or ship a main valve repair kit with each hydrant).
 10. 6” MJ inlet
 11. Two 2 1/2” hose nozzles and one pumper nozzle with national standard hose threads
 12. 1 1/2” point to flat pentagon operating nut
 13. The operating nut shall be one-piece 1.25” pentagon ASTM B-584 bronze with bronze hold down nut.
 14. The operating stem shall be two pieces with a stainless steel safety coupling containing an internal stop to prevent the coupling from sliding into the lower barrel when the hydrant is stuck.
 15. Saucer type tamper proof cap compatible with current Water and Fire Dept wrenches.
 16. The bonnet assembly shall have a grease reservoir to lubricate the stem threads and bearing surfaces each time the hydrant is operated. Lubrication system shall be sealed from the waterway and external contaminants by use of “o” ring seals.
 17. Anti-friction washer above the thrust collar to minimize operating torque.
 18. Upper barrel painted Safety Yellow with Sherwin Williams Kem 400 paint. The bonnet shall also be covered with Class 2 Glass Beads.
 19. The upper valve plate, seat ring, and drain ring must be ASTM B-584 bronze and work together to form an all bronze drain way. Drains through an iron shoe must be bronze lined.
 20. Two internal and two external drain valves must be provided and be an integral part of the one-piece bronze upper valve plate. They shall drain the barrel when the hydrant is closed and seal shut when the hydrant is opened.
 21. The bronze seat ring shall thread into a bronze drain ring providing a bronze-on-bronze connection. Seat rings shall be “o” ring pressure sealed.
 22. The shoe inlet size and connection type will be specified by the City and must have ample blocking pads, and the MJ connection must have two strapping lugs to secure the hydrant to the supply piping.
 23. The interior of the shoe including the lower valve plate and stem cap nut shall have a protective coating that meets the requirements of AWWA C-550. If a stem cap nut is utilized, it must be locked in place by a stainless steel lock washer that will prevent the cap nut from backing off during normal operation.
 24. Hydrants shall be warranted by the manufacturer against defects in materials or workmanship for at least 10 years from the date of manufacture.

25. Hydrants shall be manufactured by Mueller or an approved equal.

- ◆ Auxiliary Hydrant valve with:
 1. Open right
 2. 6" MJ x MJ
 3. Resilient Seat
 4. "O" ring packing
 5. 2" Square wrench nut
 6. Anchor MJ Coupling Adapter 12" long
- ◆ Blow-off hydrants shall be John Kupferle Eclipse No. 85.
- ◆ Hydrants shall be equipped with tamper proof caps that will work with City operating wrenches to prevent unauthorized use of water.

METERING EQUIPMENT

- ◆ The meter box for a standard domestic service shall be a pre-assembled cast iron FORD #LYLB-141-233-T stretch yokebox with the following:
 1. Straight inlet valve with 3/4" CTS compression joint
 2. Expansion connection and two yoke end gaskets
 3. Dual check backflow preventor type Ford HHC-31
 4. Cast iron lid with "touch read" hole and locks
- ◆ The meter box for a service above 3/4" shall be concrete with a cast iron "reader" lid. The box top shall be pre-drilled with a "touch read" hole.
- ◆ Metering equipment shall be manufactured by Sensus Corporation and utilize "touch read" protocol for automated meter reading (typically provided by the City at cost).
- ◆ All services 1 1/2" and over must be installed with appropriate means for bypassing the meter to allow for maintenance and testing.
- ◆ All meter installations shall have a minimum of 4" of gravel (#GA No. 89 ASTM89) installed below the meter box and a concrete block can be used for bringing up to grade.
- ◆ Backflow equipment must satisfy City, State, and Federal requirements (See City of LaGrange Backflow Prevention and Cross-Connection Control Manual).
- ◆ The meter box for developments with sewer service and expecting that a large number of irrigation meters will be installed shall be a pre-assembled cast iron FORD Double "Gulfbox" with a 1" inlet connection and the same specifications as listed above for the standard domestic service.
- ◆ Groups of four or more meters installed in the same general vicinity for apartments or other

multi-tenant developments shall be installed in a single meter pit approved by the City.

- ◆ (See drawings at end of this document.)

INSTALLATION PROCEDURES AND METHODS

Any variation in the installation methods discussed below requires prior written approval from the Water Superintendent in order to be accepted.

JOINING OF PIPE

- ◆ Mechanical joint pipe shall be joined according to AWWA C600-77. Rubber gaskets, glands and bolts as required by ANSI A21.11 shall be used. Megalugs restraints are required on pipe sizes 12" and larger.
- ◆ Push-on pipe shall be joined according to AWWA C600-77 and shall be in accordance with manufacturer requirements.
- ◆ The inside of the bell and outside of the spigot shall be thoroughly cleaned prior to connection. The circular rubber gasket shall be flexed inward and inserted in the gasket recess of the socket.
- ◆ Gasket lubricant supplied by the manufacturer shall be applied to the gasket and spigot.
- ◆ Joints shall be installed to the "full home" depth mark on the pipe using a forked tool, jack-type tool, or other approved tool.

PIPE LAYING

- ◆ All work must be inspected by the City prior to covering-up. It is the responsibility of the contractor to ensure that the City is properly notified.
- ◆ Steel casing shall be required when crossing under streets and railroads where required by DOT, CSX regulations, or in special circumstances by the City.
- ◆ Minimum depth of cover shall be 48" unless otherwise approved in writing by the Water Superintendent.
- ◆ The maximum pipeline deflection at any point must be within manufacturer guidelines and shall in no case be more than 20".
- ◆ Pipe shall be bedded on fine, dry material free of rocks; and the trench backfilled with fine, dry material to a level of at least one-foot above the top of the pipe. Thereafter, backfilling shall be conducted in 6-inch lifts and adequately compacted. If under a street, parking lot, or sidewalk, trenches must be backfilled with #810 granite screenings.
- ◆ A continuous vinyl warning tape with aluminum backing and a #12 copper tracer wire shall be buried above all pipe.

- ◆ A horizontal separation of at least 10 feet must be maintained between water mains and any existing or proposed sewer mains. When crossing sewers, a minimum vertical separation of 18 inches edge-to-edge must be provided between the two pipes. At crossings, one full length of water pipe must be located so that both joints are as far from the sewer as possible.

BRACING OF PIPE AND FITTINGS

- ◆ Where changes in direction occur in pipelines the pipe and fittings shall be securely braced against hydraulic thrust. Concrete thrust blocks of 3,000-psi compressive strength and anchor rods shall be used as required. Megalug restraints are required on pipe sizes 12” and larger.

CONNECTION TO EXISTING WATER MAINS

- ◆ All work must be inspected and approved by the City prior to "covering up" or making tie-ins to existing water mains. Authorization and a minimum 24-hour notification are required before any work is performed on the City water system.
- ◆ Where it is necessary to disrupt service on existing lines, work will be performed at a time scheduled by the City that will be the least disruptive to customers.

PRESSURE TESTING AND DISINFECTION

- ◆ Pipe shall be cleaned as it is installed and open ends shall be protected by a watertight plug upon work stoppage.
- ◆ Each valved section of a newly installed pipeline must be flushed, filled with water, and tested at a pressure of 200 psi for six hours. Leakage rates must be less than the values in AWWA C600-77 Table 7. All detected defects must be properly corrected and a pressure test reapplied.
- ◆ After pressure testing and prior to disinfecting, the pipeline shall be thoroughly flushed through an opening that ensures a minimum of 2.5 fps.
- ◆ All pipe and fittings must be disinfected according to AWWA C601-68. Liquid chlorine or HTH shall be used to provide 50 ppm for at least 24 hours then flushed to meet normal chlorine residual requirements. Bacteriological tests shall be taken at 1-mile intervals (minimum 1 test), and the disinfecting process repeated until standards are met. Disinfecting of water lines and the disposal of heavily chlorinated water must be accomplished in accordance with AWWA Standard C651.

SERVICE LINE INSTALLATION

- ◆ Service line piping shall be installed at the same depth as the main and travel to within one foot of the meter box before turning up into the 45 degree angled curb stop in the meter box.

This depth is necessary to prevent problems from additional grading and utility installations that may occur after the service line is installed.

- ◆ All metering equipment will be located near the edge of the public right-of-way at a point that is pre-approved by the City. All piping, appurtenances, and fixtures located downstream of the outlet side of the meter, with the exception of any City owned backflow device, shall be owned, installed, and maintained by the customer.
- ◆ Due to the large variations in elevation throughout the City's service territory and a full water tank elevation of 936 feet, static pressures may exceed 120 psi in certain areas. For this reason, an evaluation of the need for a pressure-reducing device should be performed by plumbers prior to service line connection.
- ◆ The customer may hire a qualified contractor to tap the City main according to these specifications or pay the City the appropriate tap fee (except in new subdivisions where all work must be performed by the developer's contractor). Authorization and a minimum of 24-hour notice are required before performing any work on the City water system.

FIRELINES AND HYDRANT LATERALS

- ◆ Fire-lines serving hydrants and/or sprinkler equipment shall be sized to provide fire flow as required by the appropriate fire codes (call 883-2060). In no case will a pipe size less than 6" be allowed for fire protection. Each hydrant shall be connected to the fire-line via a flanged X M.J. gate valve. On customer owned fire-lines, this valve represents the point of demarcation between City and customer facilities.
- ◆ The customer may hire a qualified contractor to tap the City main according to these specifications or pay the City the appropriate tap fee (except in new subdivisions where all work must be performed by the developer's contractor). Authorization and a minimum of 24-hour notice are required before performing any work on the City water system.
- ◆ An approved backflow device must be installed on all fire-lines. Exception: Multi-family facilities may build their fire-line in accordance with City specifications and dedicate it to the City along with a 20-foot easement and pay a maintenance fee per hydrant as determined by City Ordinance.
- ◆ No potable or process water taps shall be allowed on a customer owned fire-line or hydrant lateral unless it is metered. The tap and metering equipment shall normally be installed in the same pit with the fire-line valve at the customer property line.

NEW SUBDIVISIONS

Plans for water line extensions into new areas must be submitted to the City's Engineering Division for approval. City approval does not relieve the developer from responsibility for complying with all required specifications and regulations.

During the review, approval, and construction process, steps will be taken to ensure that none of the water mains, service lines, and the structures connected to these lines are located on or in close proximity of an abandoned landfill site or any other site used for waste disposal (Rules For Safe

Drinking Water Section 391-3-5-. 10(5)).

All of the material requirements in previous sections also apply to new subdivisions.

The City currently maintains a fire suppression rating of ISO Class 2. In order to maintain this rating, fire flows along water main extensions must comply with all local codes but shall in no case be less than 3500 gallons per minute (gpm) in commercial areas or 1000 gpm in residential areas with at least a 20-psi residual pressure. The minimum pipe size allowed on major roads is 8" and the minimum size allowed within subdivisions is 6".

Hydrants shall be spaced along public streets as required by local ordinances and/or fire codes. Typically this requires a hydrant within 500 feet of each structure, which translates into every 1000 feet along city roads.

Dead-end mains are undesirable due to their impact on the effectiveness of treatment chemicals. A minimum 2" pipe loop must be provided from the end of any dead-end main. If a loop is impractical in the opinion of the City Water Superintendent, a 2" blow-off hydrant may be substituted. This requirement may be waived for 6" pipe lengths less than 1000 feet. Blow-off hydrants shall be fed by one or two 1" copper laterals as determined by the Water Superintendent.

If the developer installs all of the necessary water taps for a new Subdivision, the meter box specified above must also be installed. The City under the applicable fee structure will install metering and backflow devices as homes are constructed.

The developer warrants all installed piping on public right-of-way and/or easements for a period of 12 months.

As-built drawings must be submitted to the City prior to a final inspection and City acceptance.

STANDARD 3/4" METER INSTALLATION

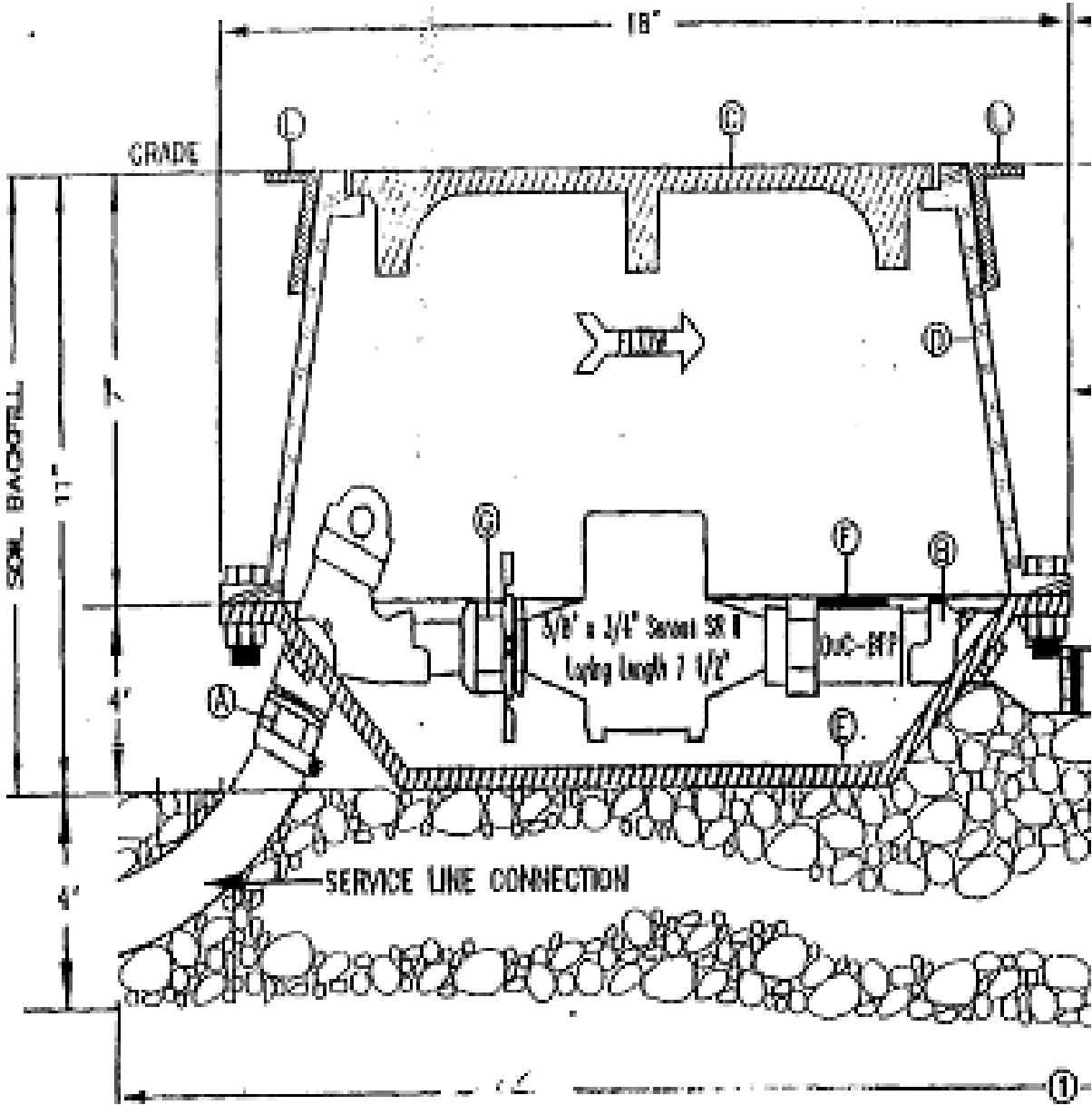

Ford Double Gulfbox

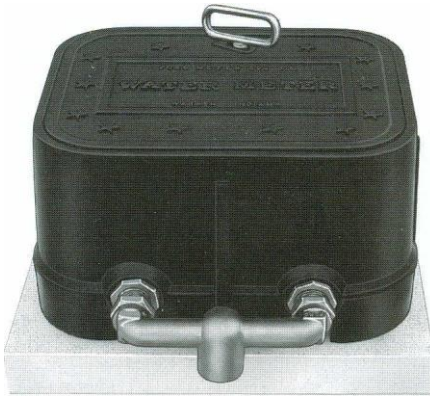

STRAIGHT INLET - STRAIGHT OUTLET

CATALOG NUMBER	DESCRIPTION		APPROX. WT. LBS.
	INLET	BOTH OUTLETS	
DG 112-243	1" Female Iron Pipe 1"	3/4" Flare Copper 3/4" Pack Joint for Copper or Plastic Tubing (CTS)* 3/4" Male Iron Pipe 3/4" Flare Copper 3/4"	42.0
DG114-243	Female Iron Pipe 1"	Pack Joint for Copper or Plastic Tubing (CTS)* 3/4" Male Iron Pipe 3/4" Flare Copper 3/4"	42.0
DG 118-243	Female Iron Pipe	Pack Joint for Copper or Plastic Tubing (CTS)* 3/4" Male Iron Pipe 3/4" Flare Copper 3/4" Pack Joint for Copper or Plastic Tubing (CTS)* 3/4" Male Iron Pipe	42.0
DG122-243	1" Flare Copper	3/4" Flare Copper 3/4" Pack Joint for Copper or Plastic Tubing (CTS)* 3/4" Male Iron Pipe	42.0
DG124-243	1" Flare Copper	Plastic Tubing (CTS)* 3/4" Male Iron Pipe	42.0
DG128-243	1" Flare Copper		42.0
DG142-243	1" Pack Joint for Copper or Plastic Tubing (CTS)* 1"		42.0
DG144-243	Pack Joint for Copper or Plastic Tubing (CTS)* 1" Pack		42.0
DG148-243	Joint for Copper or Plastic Tubing (CTS)*		42.0

ANGLE INLET - STRAIGHT OUTLET

CATALOG NUMBER	DESCRIPTION		APPROX. WT. LBS.
	INLET	BOTH OUTLETS	
DG212-243	1" Female Iron Pipe 1"	3/4" Flare Copper 3/4" Pack Joint for Copper or Plastic Tubing (CTS)* 3/4" Male Iron Pipe 3/4" Flare Copper 3/4"	42.0
DG214-243	Female Iron Pipe 1"	Pack Joint for Copper or Plastic Tubing (CTS)* 3/4" Male Iron Pipe 3/4" Flare Copper 3/4"	42.0
DG218-243	Female Iron Pipe	Pack Joint for Copper or Plastic Tubing (CTS)* 3/4" Male Iron Pipe 3/4" Flare Copper 3/4" Pack Joint for Copper or Plastic Tubing (CTS)* 3/4" Male Iron Pipe	42.0
DG222-243	1" Flare Copper	3/4" Flare Copper 3/4" Pack Joint for Copper or Plastic Tubing (CTS)* 3/4" Male Iron Pipe	42.0
DG224-243	1" Flare Copper	Plastic Tubing (CTS)* 3/4" Male Iron Pipe	42.0
DG228-243	1" Flare Copper		42.0
DG242-243	1" Pack Joint for Copper or Plastic Tubing (CTS)* 1"		42.0
DG244-243	Pack Joint for Copper or Plastic Tubing (CTS)* 1" Pack		42.0
DG248-243	Joint for Copper or Plastic Tubing (CTS)*		42.0

PARTS AND ACCESSORIES FOR DOUBLE GULFBOXES

CATALOG NUMBER	DESCRIPTION	APPROX. WT. LBS.
DGBB	Iron Body, less lid	24.8
DGBL	Lid only for Double Gulfbox	8.9
DGBLL	Lockless Lid only for Double Gulfbox	8.1
DGSSBP	Stainless Steel Base Plate for Double Gulfbox	2.8
MBLK	Yokebox Key Lid	0.5
MBVW	Yokebox Valve Wrench (18" long)	2.0

"Grip Joint for CTS can be ordered by adding "-G" to the Catalog Number.

TYPICAL MULTIPLE METER VAULT

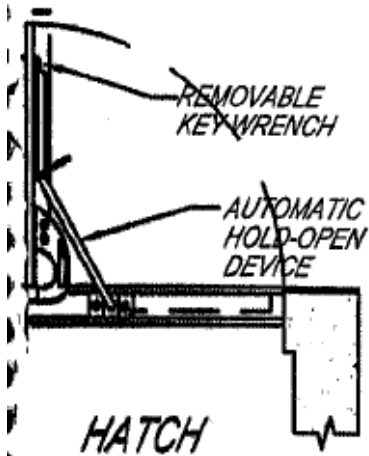
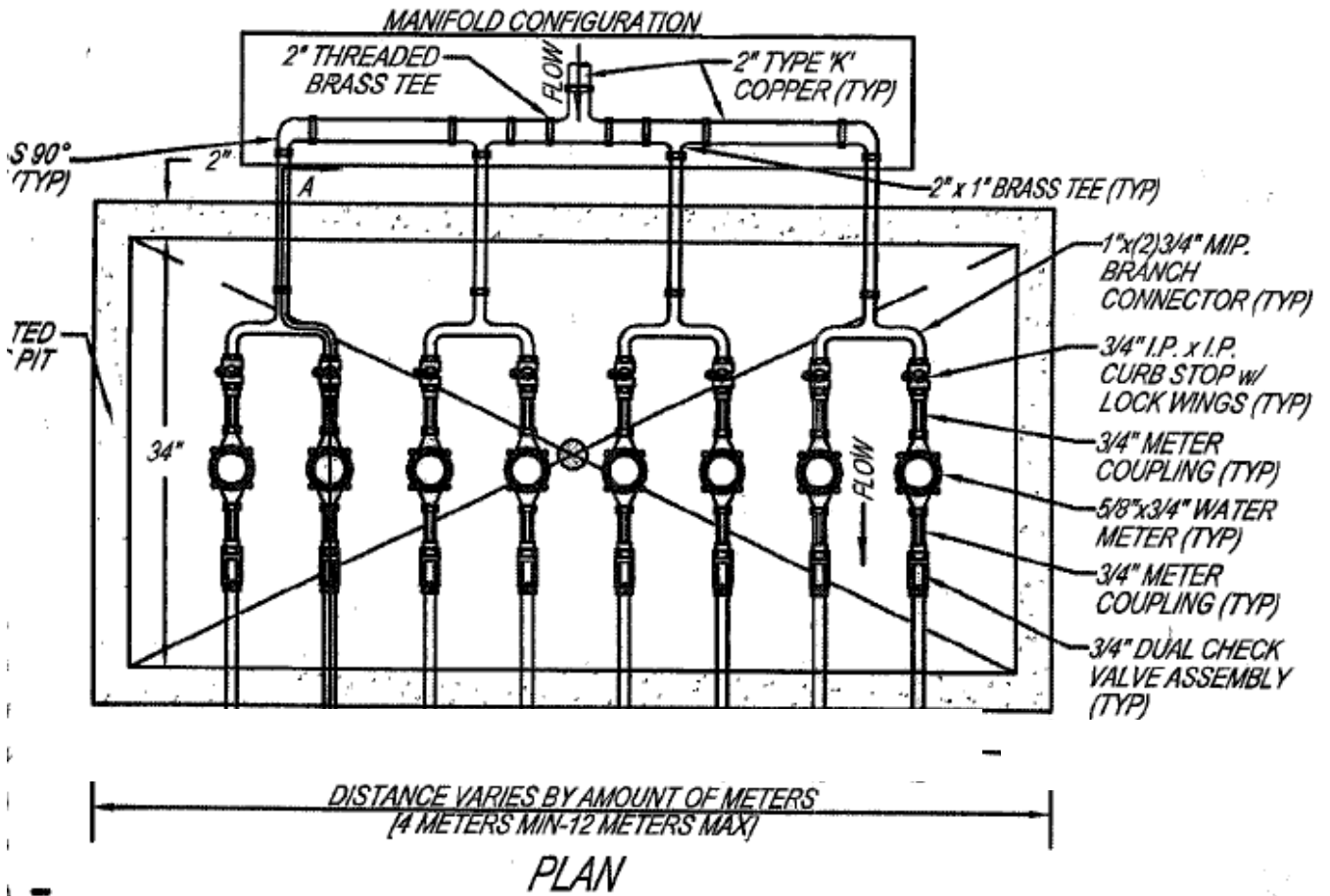

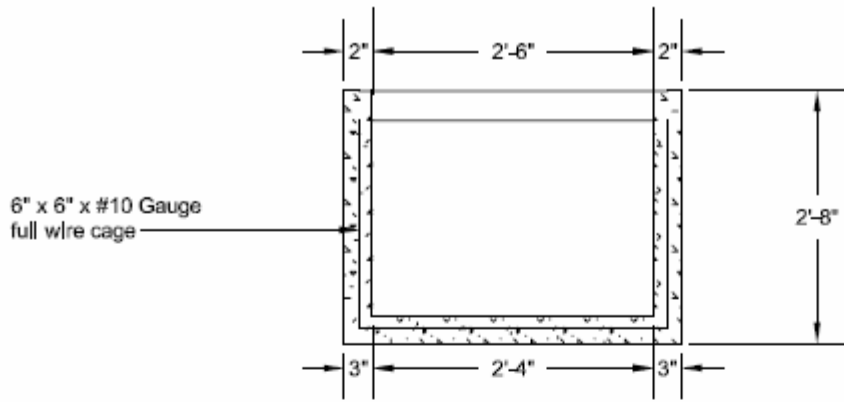

SECTION B-B

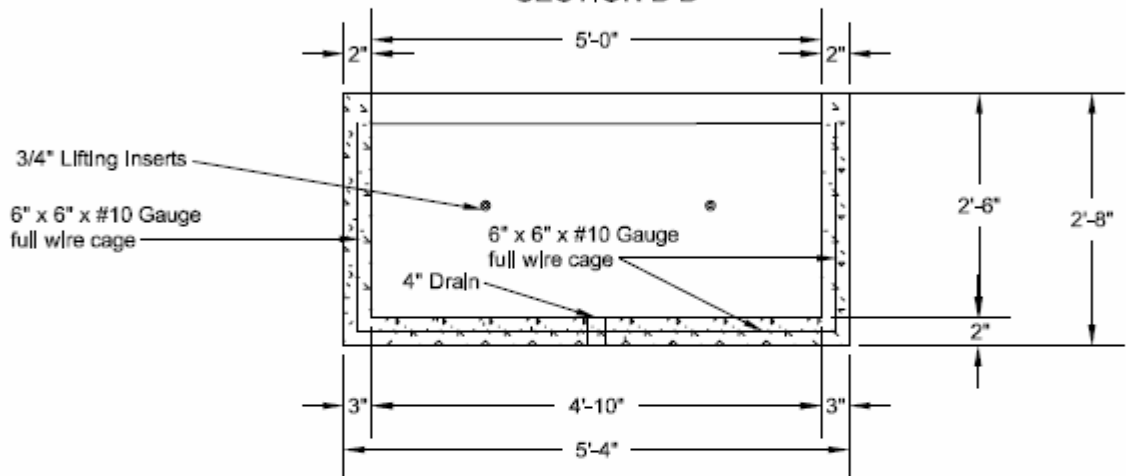

SECTION A-A

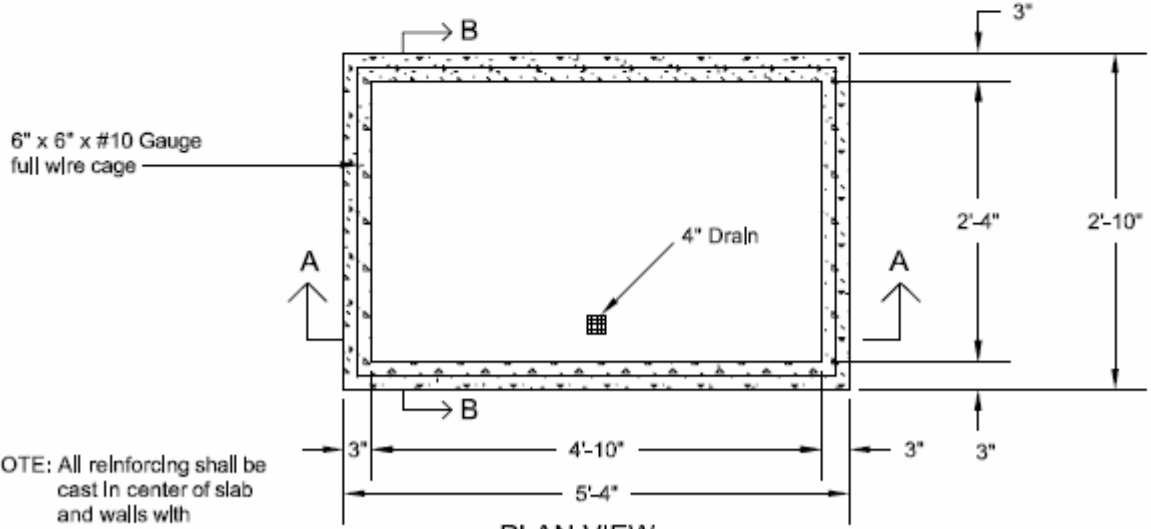

PLAN VIEW

NOTE: All reinforcing shall be cast in center of slab and walls with 6" x 6" x #10 wire



Product Number:
CPS 58 x 28
5000 PSI Concrete Mix

Designed by: CPS
Checked by: CPS
Scale: Not to Scale

Drawn by: RWP
Date: 6/15/12
DWG #: 1

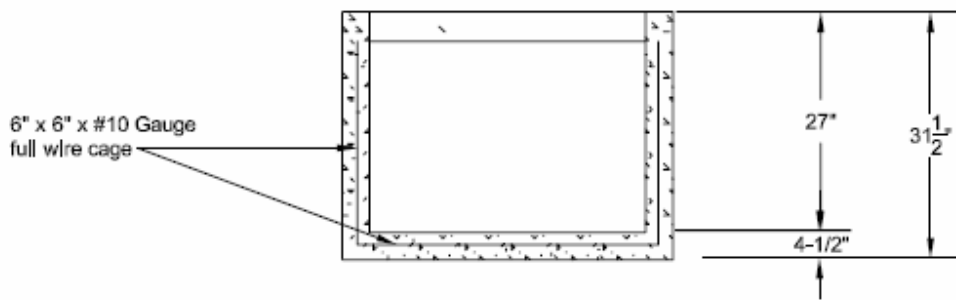

SECTION B-B

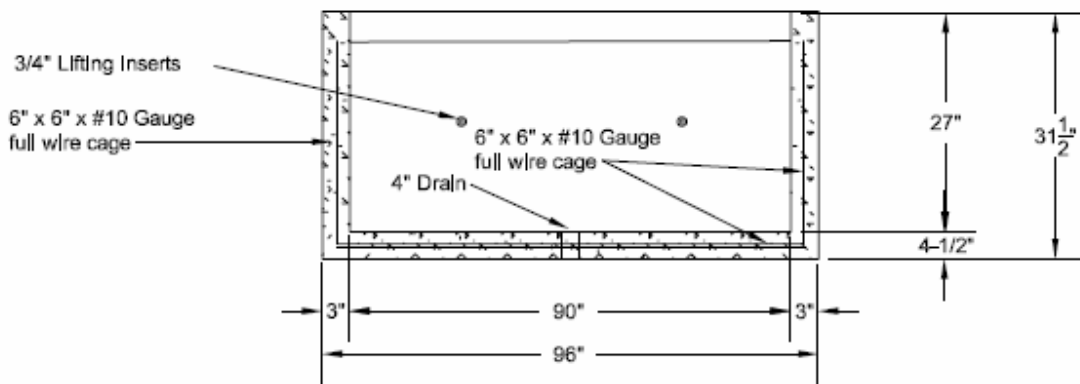

SECTION A-A

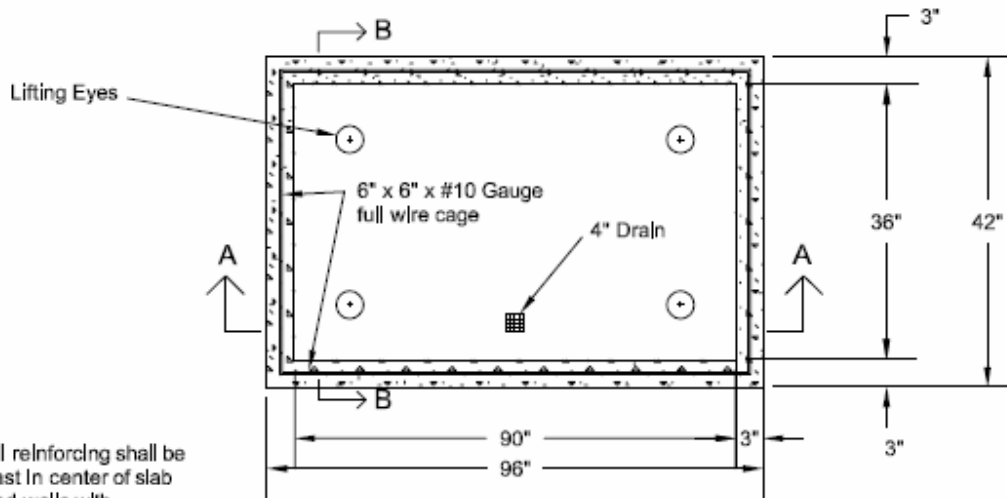

PLAN VIEW

NOTE: All reinforcing shall be cast in center of slab and walls with 6" x 6" x #10 wire



Product Number:
CPS 90 x 36S

5000 PSI Concrete Mix

Designed by: CPS

Checked by: CPS

Scale: Not to Scale

Drawn by: RWP

Date: 6/15/12

DWG #: 1

APPROXIMATE FLOW OF WATER THROUGH PIPE UNDER PRESSURE

Assumptions: Straight pipe with no valves or bends
 Open flow with no backpressure
 Pipe smoothness C=100

DISCHARGE IN GALLONS PER MINUTE						
Tap Size	Psi	Pipe Length in Feet				
		25'	50'	100'	200'	400'
3/4"	20	23	16	11	8	5
	40	34	24	16	11	8
	60	43	29	20	14	10
	80	50	34	24	16	11
1"	20	44	31	21	14	10
	40	65	44	31	21	14
	60	81	55	38	26	18
	80	94	65	44	31	21
1 1/4"	20	121	84	58	39	27
	40	177	121	84	58	39
	60	220	151	104	72	50
	80	257	177	121	84	58
1 1/2"	20	137	94	65	45	31
	40	200	137	94	65	45
	60	250	170	117	81	56
	80	290	200	137	94	65
2"	20	265	183	126	86	59
	40	385	265	183	126	86
	60	480	330	227	156	105
	80	560	385	265	183	126
4"	20	1435	1070	725	495	340
	40	2225	1535	1070	725	495
	60	2780	1910	1315	900	625
	80	3250	2225	1535	1070	725

Specification Modifications Timeline:

- 7/10/95 Meter box changed from LYMC-441-213T with angle inlet valve to larger LYL B-141-233T with straight inlet valve.
- 12/19/95 #12 copper tracer wires to be installed above all PVC pipe.
- 12/19/95 City inspection and approval required before all tie-ins to existing water mains.
- 1/4/96 12" and greater valves changed from double-disc to butterfly type.
- 1/4/96 Kennedy eliminated as an accepted manufacturer for gate valves.
- 1/4/96 Authorization and 24 hour notification required before contractor is allowed to work on the City water system.
- 1/4/96 Developer must provide as-builds for new subdivisions prior to final inspection and City acceptance.
- 2/5/96 Section added on Casing Pipe.
- 2/5/96 Retainer gland requirement added to Ductile Iron Pipe Fitting section.
- 2/5/96 Tapping Sleeve and Valve section added.
- 2/5/96 Valve marker requirement added.
- 8/27/96 Requirement for ductile iron changed from 6" and above to 8" and above except when specifically required by City.
- 7/24/97 Requirement for ductile iron changed to 6" and above.
- 9/1/98 Add concrete pad for tapping sleeve/valve.
- 9/1/98 Two-inch valve changed from gate to ball.
- 9/1/98 Specify Ford type or equal for meter box.
- 9/1/98 Require warning tape for ductile pipe.
- 9/7/99 Allow dedication of private fire-line to City in exchange for easement and hydrant maintenance fee.
- 10/29/01 Prior written approval required by the Water Superintendent before any variation from the specifications will be accepted.
- 10/29/01 Service line depth will be the same as the main before turning up at a 45 degree angle into the meter box curb stop.
- 3/5/02 Casing required to clarify that it is only required when mandated by DOT, CSX, or

in special circumstances by the City.

- 12/4/02 Class 50 ductile iron pipe changed to Special Thickness Class 50 for clarification.
- 1/3/03 Standard meter installation drawing added.
- 7/14/04 Double Gulfbox required for subdivisions with sewer to allow for irrigation meter installations
- 8/12/04 Hydrants require a tamper proof cap. Groups of four or more meters may be required to be installed in a single meter pit.
- 10/26/06 Other DI Pipe manufacturers allowed with prior approval from the City.
- 11/27/06 Fire flow requirements modified to maintain ISO Class 2 rating.
- 2/5/07 Hydrant specifications expanded
- 2/15/08 Gate valves up to 12” and butterfly valves over 12” in size.
- 3/7/13 Megalugs required on mechanical joints 12” and larger in size.
- 7/9/14 Added drawings for multi-meter box required for four or more meters in a group.
- 7/10/14 Added water flow table
- 2/12/16 Added spacing requirement for fire hydrants along roadways.
- 7/29/16 Fire hydrants must be Mueller or approved equal.
- 7/30/2018 Blow-off hydrants shall be fed by one or two 1” copper laterals as determined by the Water Superintendent.
- 11/15/2019 Added the requirement to use #810 granite screenings for backfill under hard surfaces.
- 11/15/2019 The requirement to install a customer full-open valve near the curb as required by Section 606 of the International Plumbing Code has been removed from these water specifications and will be enforced by the City building office.
- 1/17/2020 Changed ductile iron pipe from special class 50 to pressure class 350 unless otherwise specified by project. Changed mechanical joint fittings from pressure class 250 to pressure class 350.